

## Fitting of Door Finger Protector® on doors with push bars

Examples for fitting Door Finger Protector® to door with push bar mechanism.

1cm gap between door frame and push bar.

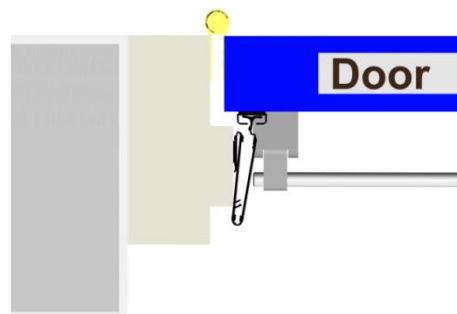
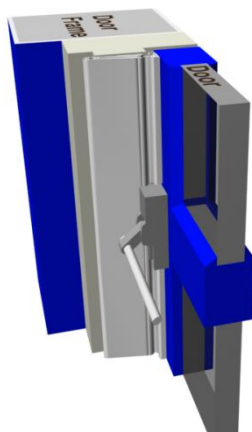
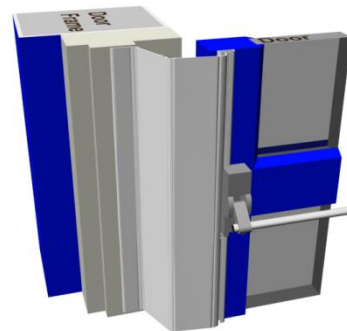
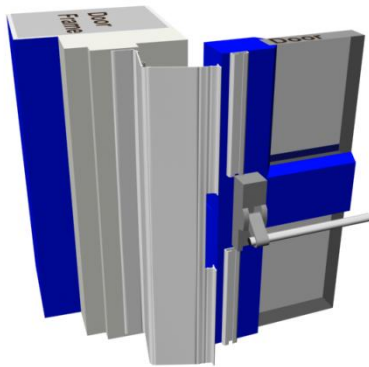
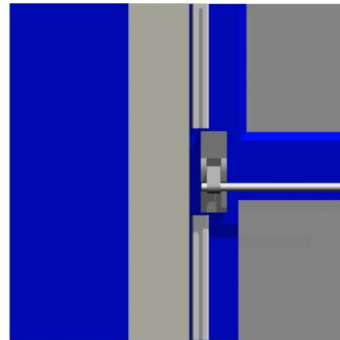
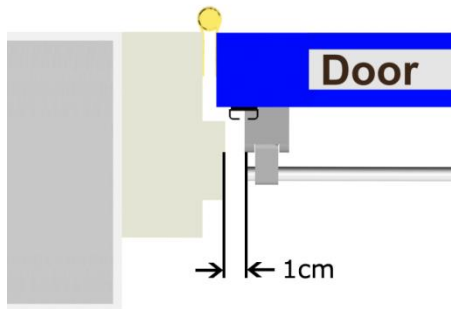

2.2cm gap between door frame and push bar.

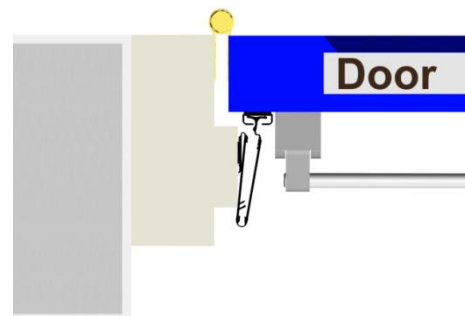
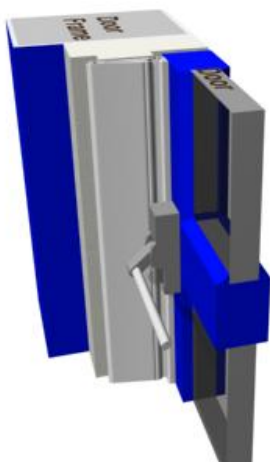
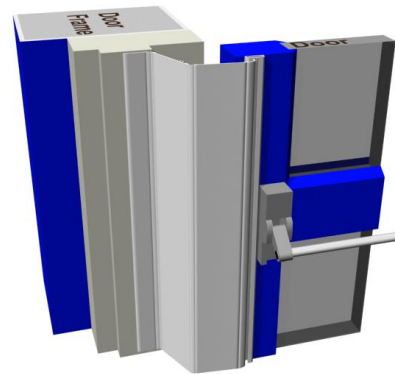
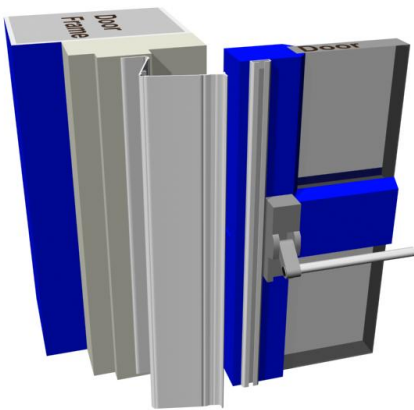
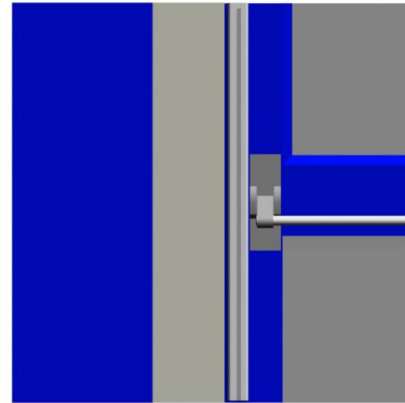
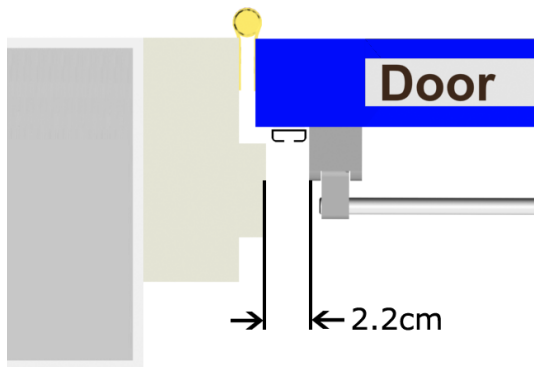

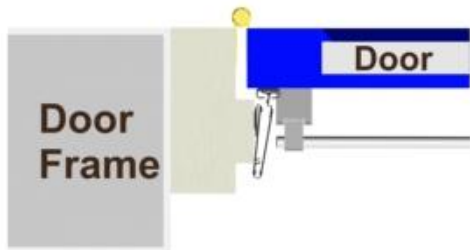

Door closed

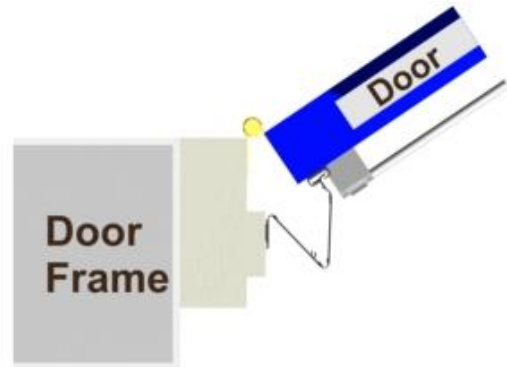

Door half open

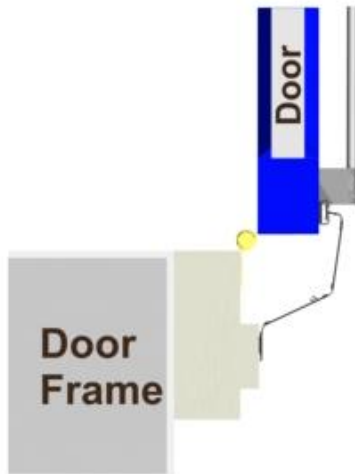

Door open 90deg